

Track Light

TRACK-SF-P-20W

Picture

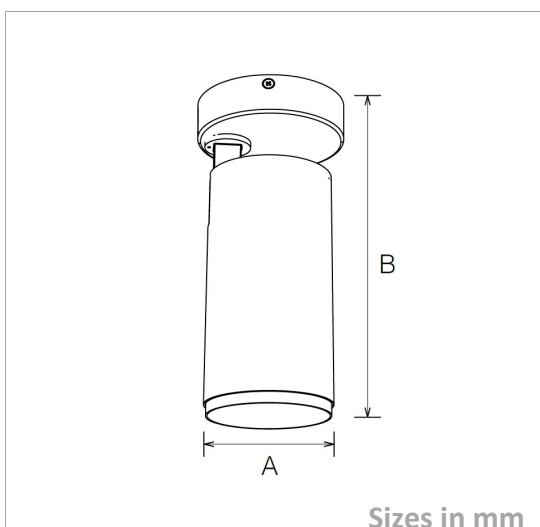

Packing

UnitVolum (CBM)	0,0035904
Unit GW (kg)	0,92
Qty per carton	12

Description

Type	LED Track Light
Connection	Pattern

Electrical Parameters

Gr. Power	20W ±5%
InputVoltage	AC200-240V
Driver	Internal
Dimmable	Not dim.

Lighting Parameters

Beam Angle	24/36/60
Colors	2700°K; 3000°K; 4000°K; 5000°K
Lumens	2250
CRI	80Ra

Structure Parameters

Fixture Color	White; Black
Cover	PMMA
Dimensions	A85*B241mm

Protection Parameters

Rating	IP20/650°GW
Electrical Class	Class I
Lifetime	>50.000h
Warranty (Years)	3

Options

Dimmable	Triac <input type="checkbox"/>	0-10V <input type="checkbox"/>	1-10V <input type="checkbox"/>	DALI <input type="checkbox"/>
CRI	>90Ra <input checked="" type="checkbox"/>	>92Ra <input type="checkbox"/>	>95Ra <input checked="" type="checkbox"/>	>98Ra <input type="checkbox"/>
Other				