

## Downlight Water resistant

### DWR172-179-IP54-25W

#### Picture

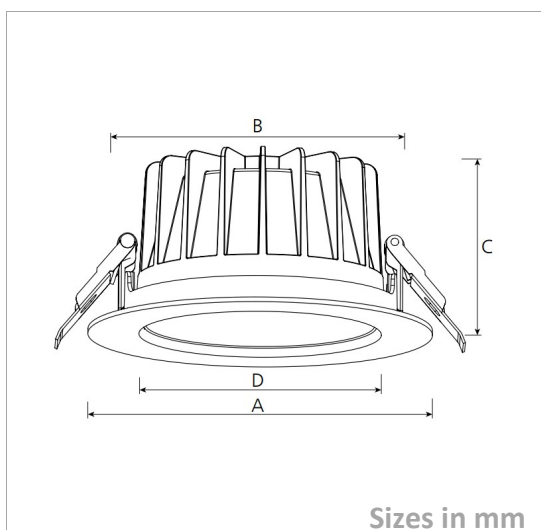

#### Packing

UnitVolum (CBM)	0,0048144
Unit GW (kg)	0,8
Qty per carton	12

#### Description

Type	LED Downlight Water resistant
Connection	Wire

#### Electrical Parameters

Gr. Power	25W ±5%
InputVoltage	AC200-240V
Driver	External
Dimmable	Not dim.

#### Lighting Parameters

Beam Angle	80
Colors	3000°K; 4000°K; 5000°K; 5700°K
Lumens	2300-2550
CRI	80Ra

#### Structure Parameters

Fixture Color	White; Black; Silver
Cover	Clear
Dimensions	A:172*C:78*D:102mm (B:150-165)

#### Protection Parameters

Rating	IP54/IK06/850°GW
Electrical Class	Class I <input type="checkbox"/> Class II <input checked="" type="checkbox"/> Class III <input type="checkbox"/>
Lifetime	>50.000h
Warranty (Years)	3

#### Options

Dimmable	Triac <input checked="" type="checkbox"/> 0-10V <input type="checkbox"/> 1-10V <input type="checkbox"/> DALI <input type="checkbox"/>
CRI	>90Ra <input type="checkbox"/> >92Ra <input type="checkbox"/> >95Ra <input type="checkbox"/> >98Ra <input type="checkbox"/>
Other	Optional: Flicker free driver; CCT switch; Reflector: White, Black, Silver matt, Chrome