

Downlight Water resistant

DWR172-178-P-18W

Picture

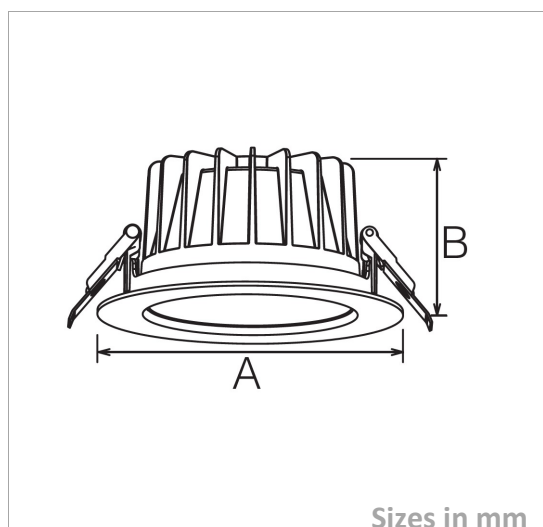

Packing

UnitVolum (CBM)	0,0048144
Unit GW (kg)	0,84
Qty per carton	12

Description

Type	LED Downlight Water resistant
Connection	Wire

Electrical Parameters

Gr. Power	18W ±5%
InputVoltage	AC200-240V
Driver	Included
Dimmable	Not dim.

Lighting Parameters

Beam Angle	24/36/60
Colors	2700°K; 3000°K; 4000°K; 5000°K
Lumens	2000-2200
CRI	80Ra

Structure Parameters

Fixture Color	White; Black; Silver; Chrome
Cover	Lens
Dimensions	dia A:172*B:90mm (hole 150-165)

Protection Parameters

Rating	IP54 (front); UGR<19
Electrical Class	Class II
Lifetime	>50.000h
Warranty (Years)	3

Options

Dimmable	Triac <input checked="" type="checkbox"/> 0-10V <input type="checkbox"/> 1-10V <input type="checkbox"/> DALI <input checked="" type="checkbox"/>
CRI	>90Ra <input type="checkbox"/> >92Ra <input type="checkbox"/> >95Ra <input type="checkbox"/> >98Ra <input type="checkbox"/>
Other	Optional: Reflector: White, Black, Silver matt (UGR <25), Bright silver (UGR<19)