

Surface Downlight

DWR170-MD-SF-P-60W

Picture

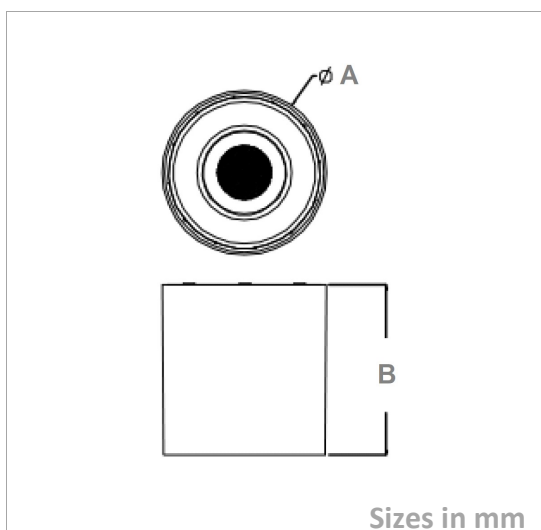

Packing

UnitVolum (CBM)	0,00773262
Unit GW (kg)	0
Qty per carton	8

Description

Type	LED Surface Downlight
Connection	Wire

Electrical Parameters

Gr. Power	60W ±5%
InputVoltage	AC100-277V
Driver	Internal
Dimmable	Not dim.

Lighting Parameters

Beam Angle	20/40
Colors	2700°K; 3000°K; 4000°K
Lumens	4800+/-10%
CRI	90Ra

Structure Parameters

Fixture Color	White; Black
Cover	Lens
Dimensions	dia170*182mm

Protection Parameters

Rating	IP65/UGR<19
Electrical Class	Class II
Lifetime	>50.000h
Warranty (Years)	5

Options

Dimmable	Triac <input checked="" type="checkbox"/> 0-10V <input checked="" type="checkbox"/> 1-10V <input type="checkbox"/> DALI <input checked="" type="checkbox"/>
CRI	>90Ra <input type="checkbox"/> >92Ra <input type="checkbox"/> >95Ra <input type="checkbox"/> >98Ra <input type="checkbox"/>
Other	Reflector color for choice: black, white, chrome, gold